

LED

()



DC 24V

()

ORDER CODE : CFF400

- 40W
- DC24V
- 80RA
- 5700k, 3000k ,
- IP68
- 1KG
- 0.9
- -30 ~ 50

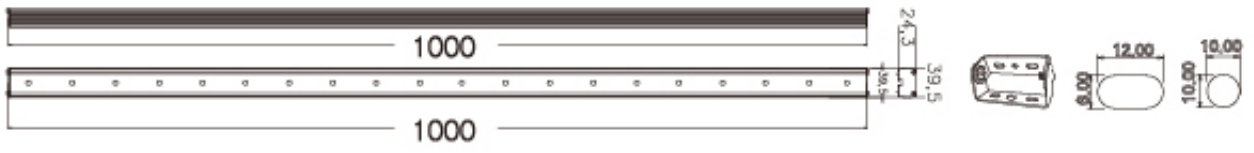

, 가

1. ()



2. [DMX512 +] ()



3. (가)



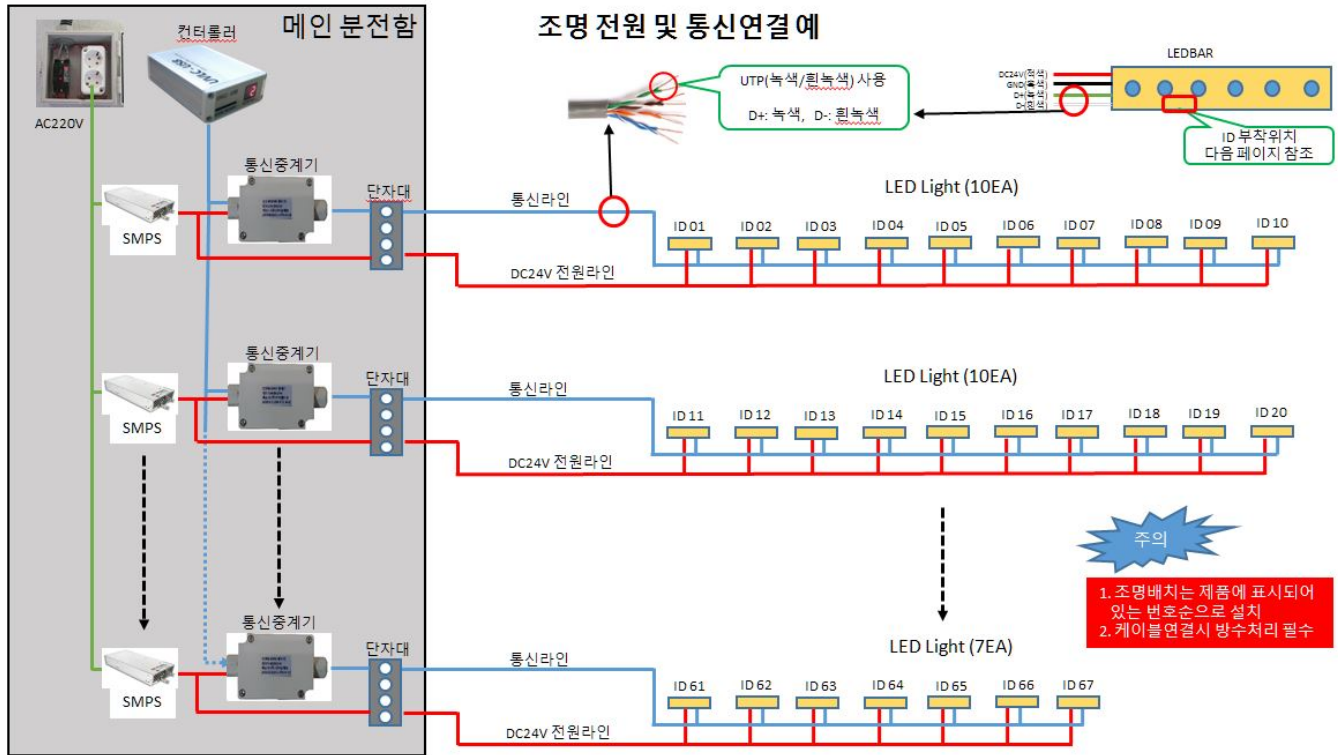

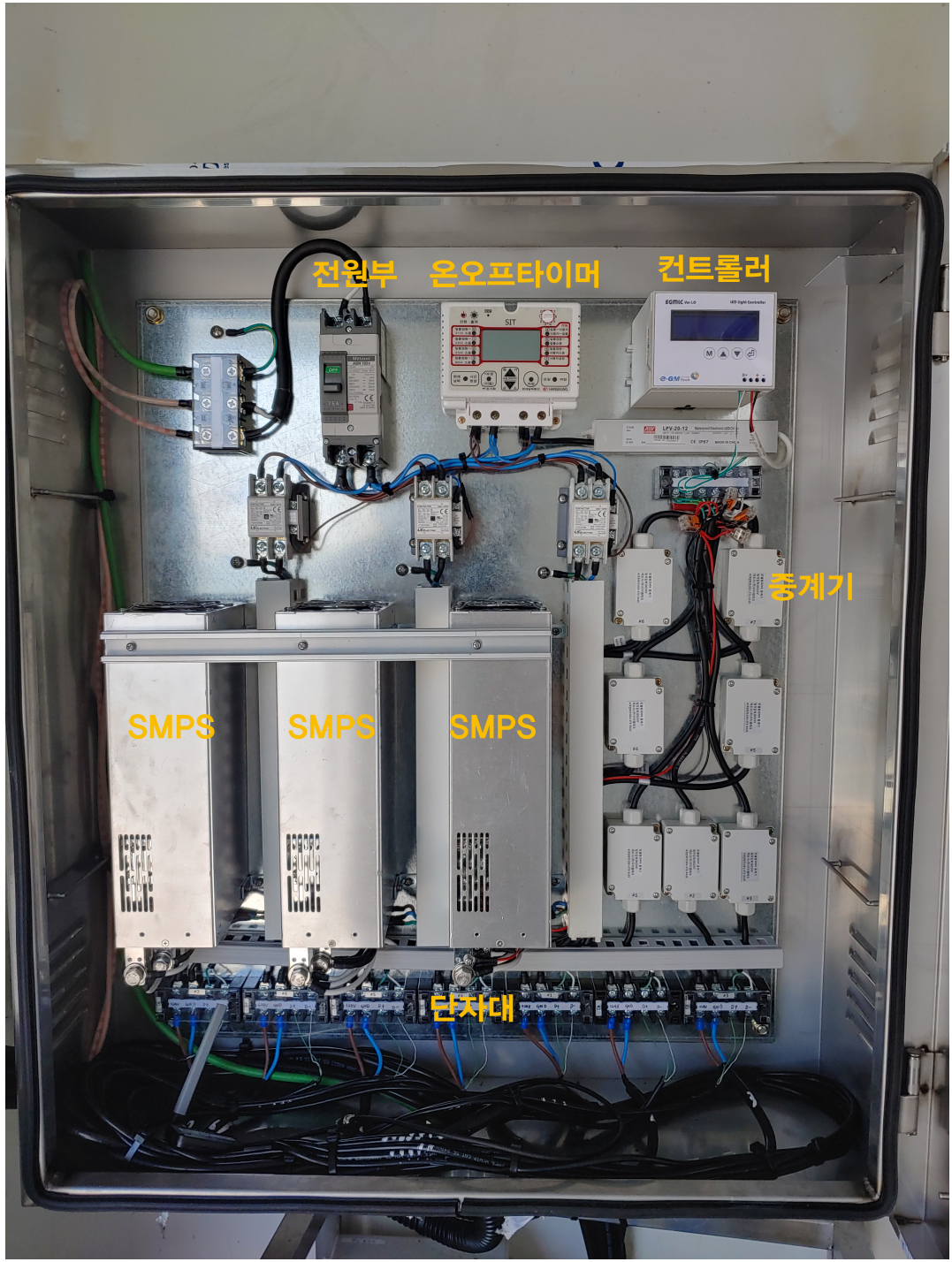

LED () ,

■ DC24V TYPE



스마트 원격 항만 방파제조명 (교각경계표시등)



DMX512 + 중계기를 이용, 핸드폰으로
원격컨트롤이 가능한 고내구성 LED라인투광기

- 주광색,전구색 및 컬러별 점등 가능
- 핸드폰(앱)을 이용 다양한 퍼포먼스 가능함
- 고내구성 100% 방수, 방습, 내염 (IP68 및 관련기술특허)
- 방파제 및 교각경계조명으로 인식은 물론 경관미 탁월



■ 제품사양 -광학적,기술적,전기적 사양

입력전압	소비전력	조사각	수 명
DC24V	40W	120°	30000시간
방수등급	무게	작동온도	조명 빛 색상
IP68	1.5Kg	-20~40℃	주광색, 전구색, RGB풀컬러

■ 제품치수 (1000mm X 39.5mm X 24.3mm)

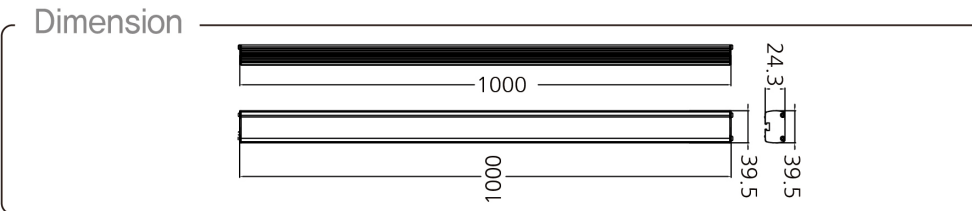

■ 적용분야 (방파제 ,등대 ,교각)

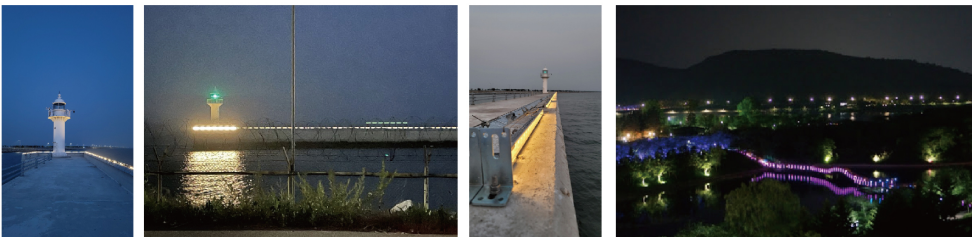

1. 가
(-) -> LTE -> LTE -> LTE

-> LTE () -> -> (-)

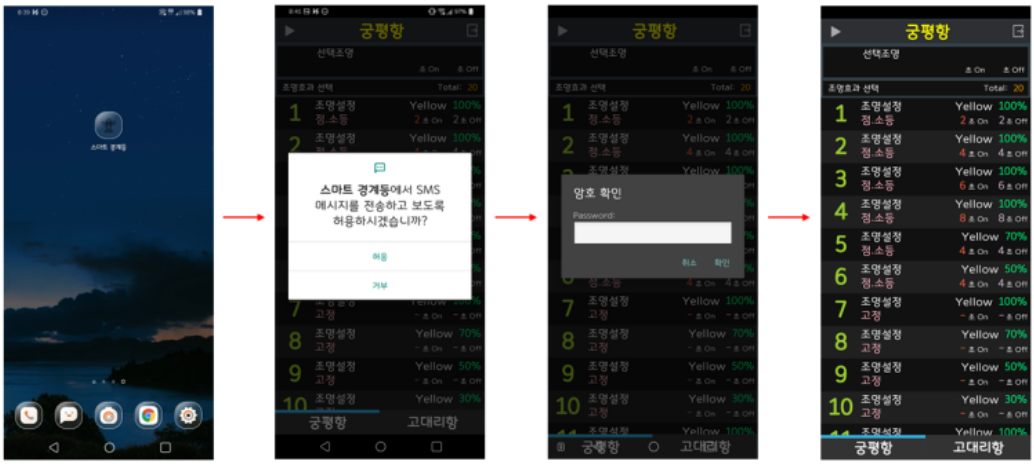
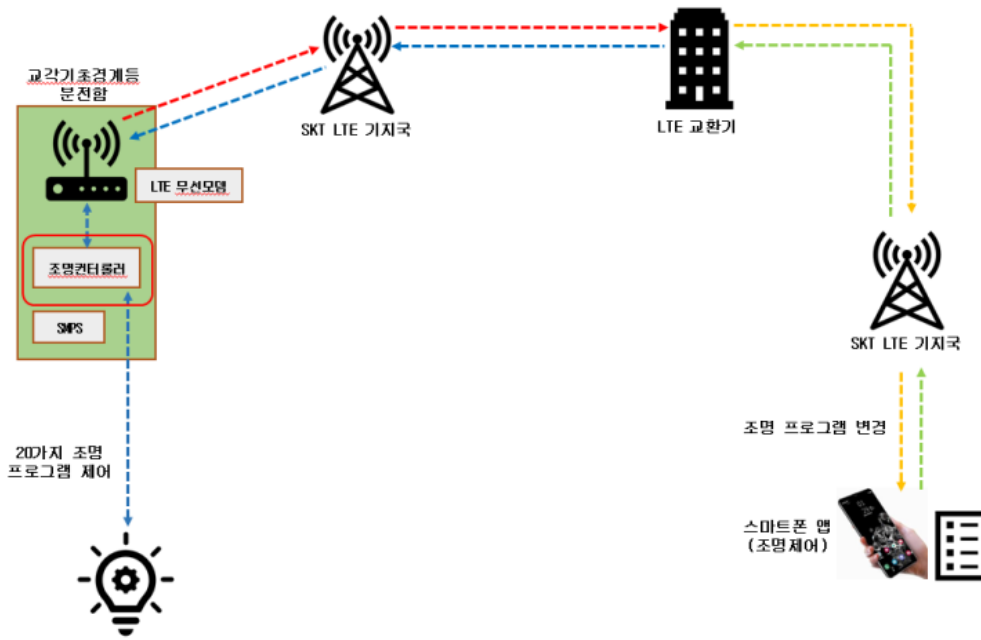

2. 가

3. LED 가 LED

4. 100% ,

IP68. , , 가 가 .

5. (AL6063) & Sus304

- 가 , 가

- , .

AL6063

- AL6063

가

가 가

- Sus304 . 가



6.

- 8 ,

- 60 , , , ,

- 가 가 ,

7.

- :
- : , 가
- : 50cm, 1m

STELLON

생산물배상책임보험
MERITZ
메리츠화재
1억원

든든하니깐!
믿고 구입하세요!!

이지엠테크
메리츠화재 생산물배상
책임보험 서비스 가입

이지엠테크는 메리츠화재 생산물배상책임 보험에
가입되어 문제가 생길시 1억원 한도내에서 보상해드립니다